



Icron USB 3-2-1 Raven™ 3124

4-Port USB 3.1, 200m Multimode Fiber
Point-to-Point Extender System

User Guide



Thank you for purchasing the USB 3-2-1 Raven™ 3124.

Please read this guide thoroughly.

This document applies to the following part numbers:

Model	North American System	European System	United Kingdom System	Australia System	Japan System
Icron USB 3-2-1 Raven 3124	00-00437	00-00438	00-00439	00-00440	00-00441

FCC Radio Frequency Interference Statement Warning

This device complies with Part 15 of the FCC rules. Operation is subject to the following two conditions: (1) this device may not cause harmful interference, and (2) this device must accept any interference received including interference that may cause undesired operation.

CE Statement

We, Icron Technologies Corporation, declare under our sole responsibility that the USB 3-2-1 Raven™ 3124, to which this declaration relates, is in conformity with European Standards EN 55022, EN 55024, EN 55032 and EN 61000.

IC Statement

This Class B digital apparatus complies with Canadian ICES-003 Issue 6.

WEEE Statement

The European Union has established regulations for the collection and recycling of all waste electrical and electronic equipment (WEEE). Implementation of WEEE regulations may vary slightly by individual EU member states. Please check with your local and state government guidelines for safe disposal and recycling or contact your national WEEE recycling agency for more information.

Product Operation and Storage

Please read and follow all instructions provided with this product, and operate for intended use only. Do not attempt to open the product casing as this may cause damage and will void warranty. Use only the power supply provided with this product (if applicable). When not in use, product should be stored in a dry location between -20°C and 70°C.

©2018 All rights reserved.
Document #90-01579-A01

Contents

Introduction	3
Product Contents	3
Features	3
The LEX Unit	4
The REX Unit.....	5
Installation Guide	6
Installing the USB 3-2-1 Raven 3124 System	6
Fiber Optic Cabling.....	6
Requirements	6
Preparing Your Site	6
Installing the LEX Unit	7
Connecting the LEX to the REX	7
Installing the REX Unit.....	7
Checking the Installation	7
Connecting a USB Device.....	8
Compatibility	8
Optional Ethernet Pass Through Connection	8
Optional USB Extender Mounting Options	9
Troubleshooting	11
Warranty Information	14
Obtaining Warranty Service	14
Specifications.....	15
Contacting Technical Support	16
Technical Glossary	17

Introduction

This guide provides product information for the USB 3-2-1 Raven™ 3124, installation instructions and troubleshooting guidelines. The instructions in this guide assume a general knowledge of computer installation procedures, familiarity with cabling requirements and some understanding of USB devices.

 NOTE: Notes provide additional information that could be useful.

 CAUTION: Cautions provide important information about an operational requirement.

Product Contents

Your Raven 3124 extender system contains:

- LEX (Local Extender)
- REX (Remote Extender)
- USB 3.1 Gen 1 Cable
- LEX 24V DC 1A International Power Adapter
- REX 24V DC 2.71A International Power Adapter
- 2 x Country Specific Power Cables
- Quick Start Guide

Features

The Raven 3124 incorporates ExtremeUSB-C™ technology, enabling users to extend USB 3.1 beyond the standard 3m cable limit for USB 3.1 peripheral devices. This extender system is composed of two individual units, the LEX and the REX, and has the following key features:

- Up to 200m of extension when directly connected over OM3 multimode fiber
- Support for new USB 3.1 Gen 1/2 host controllers and devices (up to 5 Gbps)
- Support for all device USB types
- Backwards compatible to USB 2.0 devices

The Raven 3124 includes the ExtremeUSB-C™ suite of features:



- Transparent USB extension supporting USB 3, 2 and 1
- True plug and play; no software drivers required
- Works with all major operating systems: Windows®, macOS™, Linux® and Chrome OS™

 The Raven 3124 only works with OM3 multimode fiber or higher grade.

The LEX Unit

The LEX unit connects to the computer using a standard USB 3.1 Gen 1 cable. Power for this unit is provided by the included 24V 1A adapter.

Front View

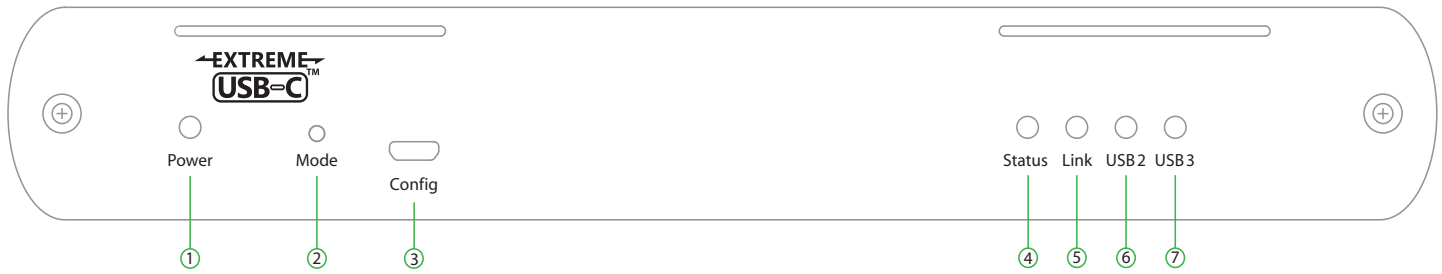

Rear View



ITEM	TYPE	DESCRIPTION
1	Power LED	LED is SOLID ON when DC is supplied to the extender unit. LED is OFF when no power is supplied by the AC Adapter
2	Mode	Reserved for manufacturer use.
3	Config	Reserved for manufacturer use.
4	Status LED	LED is SOLID ON when system is functioning normally. LED BLINKS when system is booting OR to indicate a temperature warning in unison with the LINK, USB 2, and USB 3 LEDs.
5	Link LED	LED is SOLID ON when LEX is linked to an opposite REX. LED is OFF when there is no connection between the LEX and REX units.
6	USB 2 LED	LED is SOLID ON when an active USB 2 connection is established through the extender system. LED BLINKS when the USB 2 connection is suspended/asleep. LED is OFF when no USB 2 connection is detected.
7	USB 3 LED	LED is SOLID ON when an active USB 3 connection is established through the extender system. LED BLINKS when the USB 3 connection is suspended/asleep. LED is OFF when no USB 3 connection is detected.
8	LAN Port (100 Mbps)	Ethernet pass through channel connects to a network or Ethernet device.
9	Link Port	Extension link Duplex LC fiber optic transceiver port.
10	USB Host Port	USB 3 Type B receptacle used to connect LEX to USB 3 Host computer.
11	DC Power Port	Locking connector for the included power adapter – accepts 24VDC 1A.

The REX Unit

The REX unit provides USB 3.1 Type A ports for standard USB devices and allows you to connect up to four USB devices directly. Additional devices may be connected by attaching up to three USB hubs to the REX. The REX is powered by an external AC 24V 2.71A adapter, supplying up to 1.2 Amp per USB port.

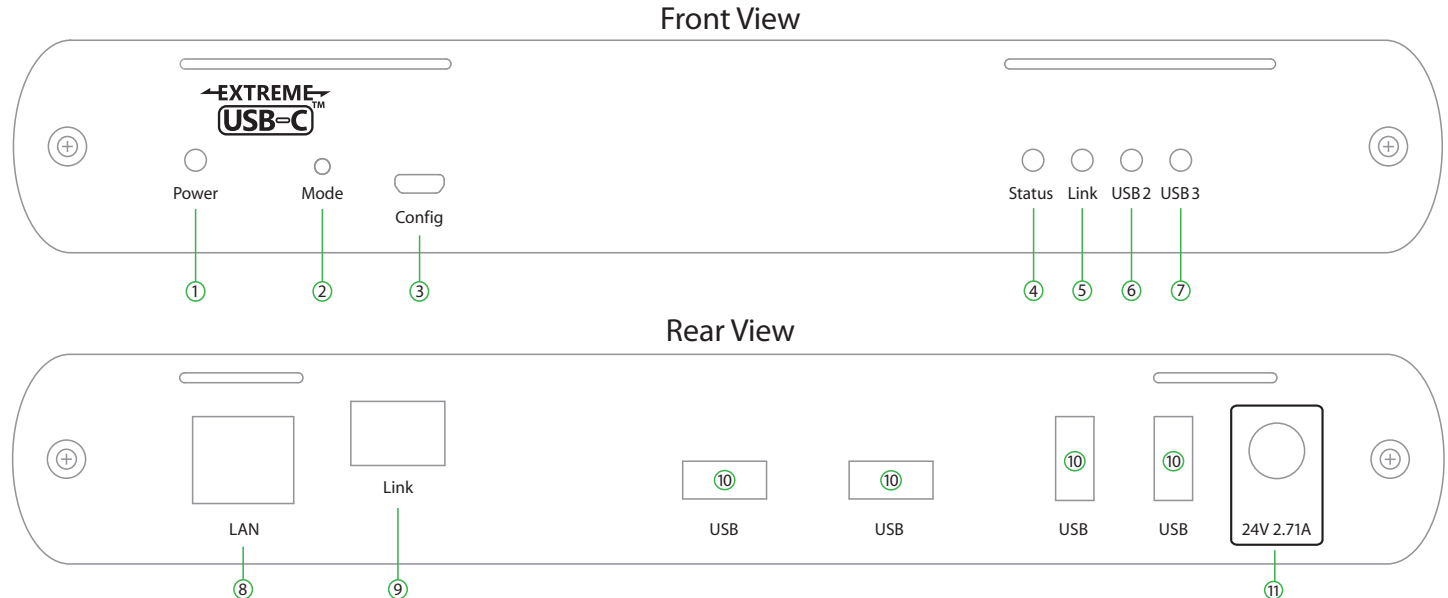

ITEM	TYPE	DESCRIPTION
1	Power LED	LED is SOLID ON when DC is supplied to the extender unit. LED is OFF when no power is supplied by the AC Adapter.
2	Mode	Reserved for manufacturer use.
3	Config	Reserved for manufacturer use.
4	Status LED	LED is SOLID ON when system is functioning normally. LED BLINKS when system is booting OR to indicate a temperature warning in unison with the LINK, USB 2, and USB 3 LEDs.
5	Link LED	LED is SOLID ON when LEX is linked to an opposite REX. LED is OFF when there is no connection between the LEX and REX units.
6	USB 2 LED	LED is SOLID ON when an active USB 2 connection is established through the extender system. LED BLINKS when the USB 2 connection is suspended/asleep. LED is OFF when no USB 2 connection is detected.
7	USB 3 LED	LED is SOLID ON when an active USB 3 connection is established through the extender system. LED BLINKS when the USB 3 connection is suspended/asleep. LED is OFF when no USB 3 connection is detected.
8	LAN Port (100 Mbps)	Ethernet pass through channel connects to a network or Ethernet device.
9	Link Port	Extension link Duplex LC fiber optic transceiver port.
10	Device Ports (Type A)	Accepts all USB devices.
11	DC Power Port	Locking connector for the included power adapter – accepts 24VDC 2.71A.

Installation Guide

Installing the USB 3-2-1 Raven 3124 System

Requirements

To complete the installation, you will also require the following items that are not included with this system:

- USB compatible computer (host computer) with a USB compliant operating system
- USB compatible device(s)
- OM3 Fiber optic cabling

Fiber Optic Link Cabling

The LEX and REX extenders are interconnected by fiber optic cabling. Duplex multimode fiber cabling is required for the Raven 3124 for extending up to 200m using 50/125µm OM3 grade cable. The cabling subsystem must provide a duplex connection with crossover, and must be terminated with Duplex LC connectors at both ends.

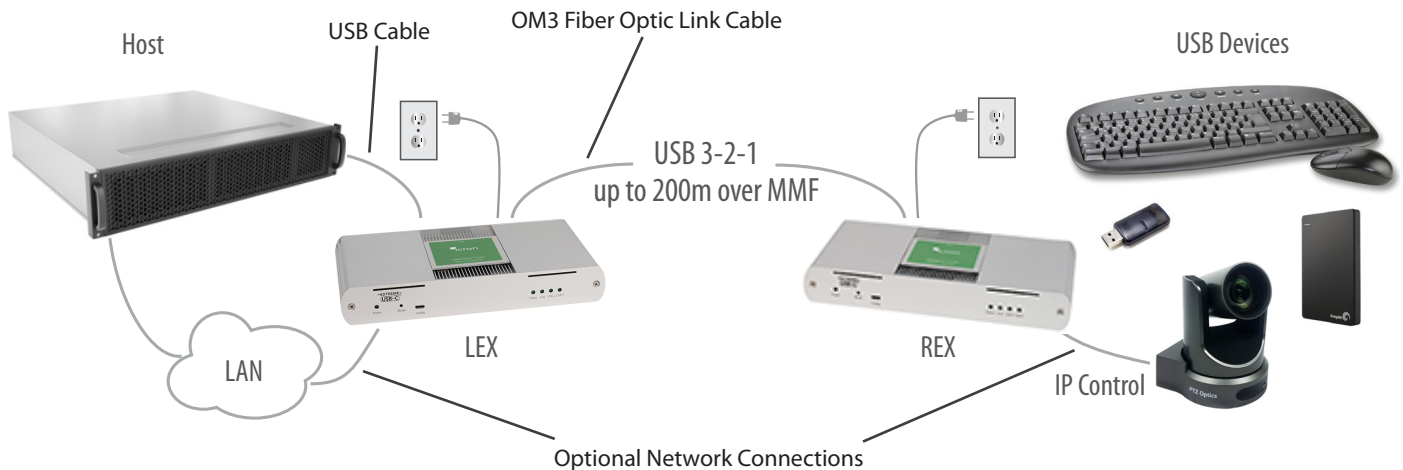

Preparing Your Site

Before installing the Raven 3124 extender, you will need to prepare your site:

1. Place the computer where desired and set it up.
2. Ensure to locate the USB device(s) within the cable-length of the computer. If not, adjust the location of the device(s) and/or computer accordingly.
3. If you are using surface cabling, the Raven 3124 supports a maximum distance of 200m over OM3 multimode fiber.
4. If using premise cabling, ensure compatible fiber optic cabling is installed between the two locations and does not to exceed the specified distance.

Installing the LEX Unit

1. Place the LEX unit near the computer.
2. Assemble the power adapter and country specific power cord together and connect them into a suitable AC outlet.
3. Connect the supplied USB 3.1 Gen cable between the LEX host port and a USB 3 port on the host computer.

Connecting the LEX to the REX

With Surface Cabling:

1. Plug one end of the fiber optic cabling (not included) into the Link port on the LEX.
2. Plug the other end of the fiber optic cabling into the Link port on the REX.

With Premise Cabling:

1. Plug one end of a fiber optic patch cord (not included) into the Link port on the LEX.
2. Plug the other end of the patch cord into the fiber optic information outlet near the host computer.
3. Plug one end of the second fiber optic patch cord (not included) into the Link port on the REX.
4. Plug the other end of the second patch cord into the fiber optic information outlet near the USB device.

Installing the REX Unit

1. Place the REX near the USB device(s).
2. Connect the power adapter to the REX.

Checking the Installation

1. On the LEX and REX units, check that the Power, Status, Link, USB 2 and USB 3 LEDs are on. If the Link LEDs are permanently off, then the cabling between the LEX and REX units may not be installed properly or is defective.
2. For Windows users (XP, 7, 8, 8.1, 10), open Device Manager to confirm that the extender system has been installed correctly. Expand the entry for Universal Serial Bus controllers by clicking the "+" sign. If the extender system has been installed correctly, you should find two separate instances of "Generic SuperSpeed USB Hub" listed.



To open Device Manager in Windows XP:

Right click "My Computer" then select: Properties >> Hardware tab >> Device Manager



To open Device Manager in Windows 7:

Open the Start Menu, right click on "Computer" then select: Manage >> Device Manager



To open Device Manager in Windows 8, 8.1 or 10:

Right click the Start Menu and then select: Device Manager

3. For macOS users, open the System Profiler to confirm that the extender system has installed correctly. In the left-hand column under Hardware, select “USB” and inspect the right hand panel. If the extender has been installed correctly, you should find it listed as two separate instances of “Hub” under the USB SuperSpeed Bus.



To open System Profiler in macOS:

Open the Finder, select Applications, then open the Utilities folder and double click on the System Profiler icon.

4. If the extender system is not detected correctly or fails to detect, please consult the Troubleshooting section in this guide.

Connecting a USB Device

1. Install any software required to operate the USB device. Refer to the documentation for the USB device, as required.
2. Connect the USB device to the device port on the REX.
3. Check that the device is detected and installed properly in the operating system.

Compatibility

The USB 3-2-1 Raven 3124 complies with USB 2.0 and USB 3.1 Gen 1 specifications governing the design of USB devices. However, there is no guarantee that all USB devices or hosts will be compatible as there are a number of different characteristics that may impact the operation of USB devices over extended distances.

Optional Ethernet Pass Through Connection

The Raven 3124 offers a 100 Mbps Ethernet pass through connection that can be used for a variety of purposes including:

- Connecting network devices
- Providing remote network access to the same location as the REX unit
- Leveraging existing cabling to provide USB 3-2-1 connectivity without losing network connectivity

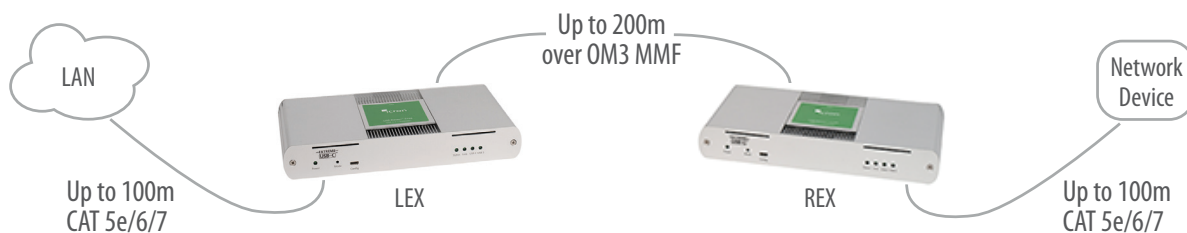

Connect any network device or access port into the RJ45 socket label “LAN” using up to 100 meters of standard CAT 5e, 6 or 7 cabling.

Optional USB Extender Mounting Options

The bottom of the enclosure features four convenient pre-drilled holes for optional mounting. Based on your requirements, choose from two available mounting options:

- 1. USB Extender Mounting Kit** (Purchased separately Order Part #10-00620 USB Mounting Kit - Silver)
- 2. USB Extender Direct Surface Mounting** (Using your own hardware, stencil provided on page 10)

OPTION 1: USB Extender Mounting Kit - each kit includes:

- 2 mounting brackets
- 4 (M3) locking washers
- 4 (M3 x 10mm) Phillips screws
- Mounting bracket installation guide (*see diagram below*)

1 kit required to mount per LEX or REX

Using a Phillips screwdriver, in the order as illustrated below, fasten and secure the provided screws, locking washers and brackets into place.

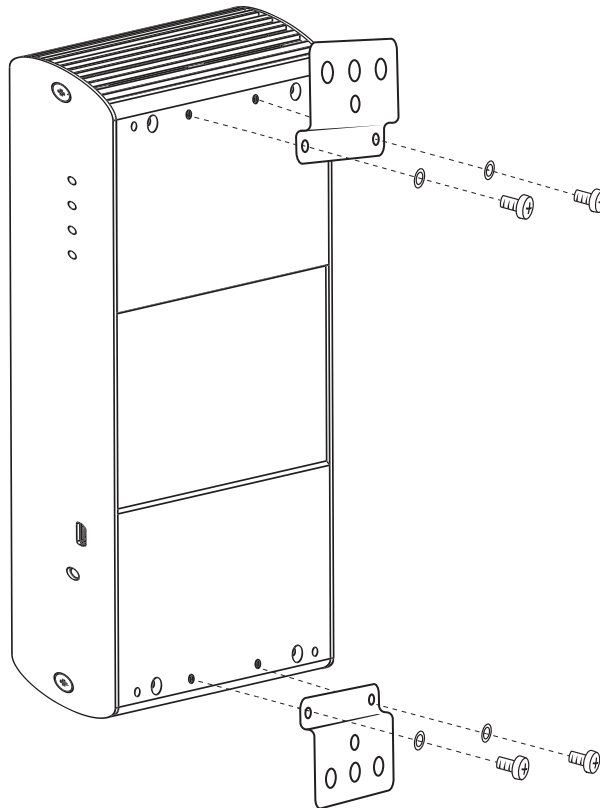

Once the bracket mounting is secured onto the extender, it is ready for mounting onto a surface. Please note you will need to provide your own screws to secure the extender using the available slots on each bracket.

OPTION 2: USB Extender Direct Surface Mounting (using your own hardware)

The bottom of the enclosure features four pre-drilled holes for optional surface mounting.

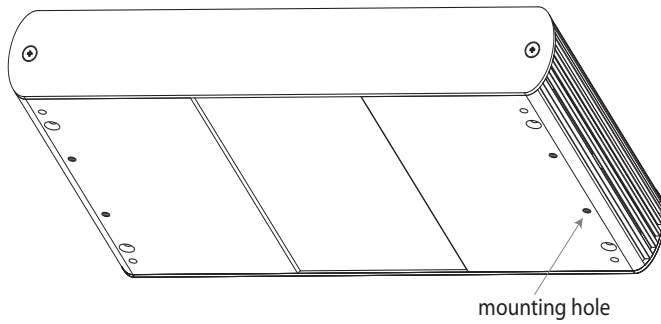

Distance between the enclosure mounting holes:
42.0mm x 205.5mm

1. Mark the center point of each of the four holes on your mounting surface either by directly measuring or printing a stencil from www.icron.com/pdf/R-M-stencil.pdf.
2. Hardware recommendation: M3 locking washers and M3 screws (4 of each per extender) noting screw length will depend upon thickness of mounting surface.
3. Drill through each of the four-hole markings on the mounting surface using a 3.97mm (5/32") drill bit.
4. Align the bottom enclosure holes to the newly drilled out holes on the mounting surface.
5. Place a locking washer on each of the four screws and using a screwdriver, fasten the extender into place.



Do not exceed a screw depth of 10mm (0.4") into the unit or damage may occur.

Direct Surface Mounting Measurement Stencil

The stencil illustration pictured below is only 50% of the original size. To access this stencil file (to scale), simply go to: www.icron.com/pdf/R-M-stencil.pdf.



Troubleshooting

The following table provides troubleshooting tips. The topics are arranged in the order in which they should be executed in most situations. If you are unable to resolve the problem after following these instructions, please contact Icron Technologies' [Technical Support](#) for further assistance.

PROBLEM	CAUSE	SOLUTION
ALL LEDs are OFF on the LEX and/or REX.	1. The LEX and/or REX is not receiving power from the AC power adapter.	<ol style="list-style-type: none"> 1. Ensure that the AC power adapter is properly connected to the LEX and/or REX. 2. Check that the AC adapter is connected to a live source of AC power. Check that the LEX and/or REX Power LED is illuminated.
POWER LED is ON, STATUS LED is OFF.	1. The unit has malfunctioned and requires re-programming.	<ol style="list-style-type: none"> 1. Contact Technical Support for assistance.
Link LEDs on the LEX and REX are OFF.	1. There is no connection between the LEX and REX units.	<ol style="list-style-type: none"> 1. Ensure that a crossover OM3 multimode fiber optic cable of no more than 200m is connected between the LEX and REX. 2. Connect a short fiber optic patch cable between the LEX and REX. Recheck the link status. If the LINK LED is now SOLID ON, the previous cable is defective or not capable of supporting the link.
LINK LEDs on the LEX and REX are SOLID ON, but the USB 2 and USB 3 LEDs are OFF.	<ol style="list-style-type: none"> 1. The host computer is not powered on. 2. The LEX is not connected to a computer. 3. The host computer does not support USB Hubs. 4. The unit is malfunctioning. 	<ol style="list-style-type: none"> 1. Disconnect all USB devices from the REX. 2. Disconnect LEX from the host computer. 3. Disconnect AC adapters from LEX and REX. 4. Reconnect the LEX to the host computer. 5. Reconnect the AC adapters to the LEX and REX. 6. Check that the LEX and REX have enumerated as USB hubs in Windows Device Manager, macOS System Profiler or using "lsusb" command in a Linux Terminal. 7. If the problem is not resolved, contact Technical Support.
The USB 2 LED is SOLID ON, but the USB 3 LED is OFF.	<ol style="list-style-type: none"> 1. The LEX is not connected to a USB 3 port. 2. The LEX is connected to the host using a USB 2 cable. 3. The USB 3 cable connecting the LEX to the host computer is defective. 4. The host computer's USB 3 controller has malfunctioned. 	<ol style="list-style-type: none"> 1. Ensure that the LEX is connected to a USB 3 port on the host computer. 2. Ensure that the included USB 3.1 Gen 1 cable is being used between the host computer and LEX. 3. Cold boot the host computer. 4. Replace the USB 3.1 Gen 1 cable with a different cable. 5. If the problem is not resolved, contact Technical Support.

PROBLEM	CAUSE	SOLUTION
<p>The USB 3 LED is SOLID ON, but the USB 2 LED is OFF.</p>	<ol style="list-style-type: none"> 1. The USB cable connecting the LEX to the host computer is defective. 2. The host computer's USB 2.0 controller has malfunctioned. 3. The host computer does not support USB 2. 	<ol style="list-style-type: none"> 1. Ensure that the included USB 3.1 Gen 1 cable is being used between the host computer and LEX. 2. Cold boot the host computer. 3. Replace the USB 3.1 Gen 1 cable with a different cable. 4. If the problem is not resolved, contact Technical Support.
<p>Both the LEX and REX extenders are working, but the USB 2 or USB 3 LEDs on the LEX and REX are blinking.</p>	<ol style="list-style-type: none"> 1. The LEX and/or REX is in suspend mode. For a variety of reasons, the host computer may place the LEX/REX into suspend mode. Typically, it is because there are no USB devices attached, the USB device is asleep, or the host computer is in a sleep state or hibernating. 	<ol style="list-style-type: none"> 1. Recover/resume the operating system from sleep or hibernate modes (refer to your operating system's documentation). 2. Connect a USB device to the REX. 3. Use the connected device. 4. If the problem persists, contact Technical Support.
<p>ALL LEDs on both the LEX and REX units are SOLID ON, but the USB device is not operating correctly, or is detected as an "Unknown Device" in the operating system.</p>	<ol style="list-style-type: none"> 1. The USB device is malfunctioning. 2. The computer does not recognize the USB device. 3. The application software for the USB device is not operating. 4. The USB extender is malfunctioning. 	<ol style="list-style-type: none"> 1. Disconnect the extender from the computer. 2. Connect the USB device directly to the host computer. 3. If the device does not operate as expected, consult the user documentation for the device. 4. Update the host computer BIOS, chipset or USB controller drivers from the manufacturer's website. 5. If the device operates as expected when directly connected to the computer, connect another device to the extender and reconnect it to the host computer. 6. If the second device does not operate, the extender may be malfunctioning. Contact Technical Support for assistance. 7. If the second device operates as expected, then the first device may not be compatible with this extender. Contact Technical Support.

PROBLEM	CAUSE	SOLUTION
<p>A USB 3 device is not enumerating as USB 3, or the operating system is notifying the user that the device can "Perform Faster if connected to a USB 3 port".</p>	<ol style="list-style-type: none"> 1. The USB device is malfunctioning. 2. The computer does not recognize the USB device. 3. The application software for the USB device is not operating. 4. The USB 3 port on the computer is malfunctioning. 5. The USB extender is malfunctioning. 	<ol style="list-style-type: none"> 1. Disconnect the extender from the computer. 2. Connect the USB 3 device directly to the host computer. 3. If the device does not operate as expected as a USB 3 device, consult the user documentation for that device or try a different USB port on the host computer. 4. Update the host computer BIOS, chipset or USB controller drivers from the manufacturer's website. 5. If the device operates as USB 3 device when directly connected to the computer, connect another USB 3 device to the extender and reconnect it to the host computer. 6. If the second device does not operate as a USB 3 device, the extender may be malfunctioning. Contact Technical Support for assistance. 7. If the second device operates as a USB 3 device as expected, the first device may not be compatible with this extender. Contact Technical Support.
<p>All LEDs are flashing and the system is operational.</p>	<ol style="list-style-type: none"> 1. Unit is or was operating at an unsafe temperature. 	<ol style="list-style-type: none"> 1. Check ambient temperature. Ensure temperature does not exceed 50°C (122°F). 2. Power cycle the unit to remove LED status.
<p>All LEDs are flashing and the system is NOT operational.</p>	<ol style="list-style-type: none"> 1. Unit has exceeded safe operating temperature. 	<ol style="list-style-type: none"> 1. Remove external sources of heat or change location of the unit. 2. Power cycle the unit to return to operation.
<p>LEDs are scrolling LEFT to RIGHT, starting with STATUS.</p>	<ol style="list-style-type: none"> 1. Unit is programming. 	<ol style="list-style-type: none"> 1. Wait for the unit to finish programming.

Warranty Information

Limited Hardware Warranty

Icron Technologies Corporation warrants that any hardware products accompanying this documentation shall be free from significant defects in material and workmanship for a period of **two years from the date of purchase**. Icron Technologies Corporation's hardware warranty extends to Licensee, its customers and end users.

The Warranty does not include repair of failures caused by: misuse, neglect, accident, modification, operation outside a normal operating environment, failure caused by service of the device by non-authorized servicers, or failure caused by a product for which Icron Technologies Corporation is not responsible. Opening the enclosures will void warranty.

Hardware Remedies

Icron Technologies Corporation's entire liability and the Licensee's exclusive remedy for any breach of warranty shall be, at Icron Technologies Corporation's option, either (a) return of the price paid or (b) repair or replacement of hardware; which will be warranted for the remainder of the original warranty period or 30 days, whichever is longer. These remedies are void if failure of the hardware has resulted from accident, abuse, or misapplication.

Limitation of Liability

The hardware warranty set forth in this agreement replaces all other warranties. Icron Technologies Corporation expressly disclaims all other merchantability and fitness for a particular purpose and noninfringement of third-party rights with respect to the hardware.

Icron Technologies Corporation dealer, agent, or employee is not authorized to make any modification extension or addition to this warranty. Under no circumstances will Icron Technologies Corporation, its suppliers or licensors be liable for any costs of procurement or substitute products or services, lost profits, loss of information or data, or any other special, indirect, consequential, or incidental damages arising in any way out of the sale of, use of, or inability to use Icron Technologies Corporation product or service, even if Icron Technologies Corporation, its suppliers or licensors have been advised of the possibility of such damages. In no case shall Icron Technologies Corporation, its suppliers and licensors' liability exceed the actual money paid for the products at issue.

Since some jurisdictions do not allow the limitation of implied warranties of liability for incidental, consequential, special or indirect damages, the above limitation may not always apply. The above limitation will not apply in case of personal injury where and to the extent that applicable law requires such liability.

Obtaining Warranty Service

To obtain warranty service, you must first contact Icron Technologies Corporation within the warranty period for a Return Material Authorization (RMA) number. Icron Technologies Corporation will not accept returns without an authorized RMA number. Prior to contacting Icron Technologies Corporation, be sure you have recorded the serial numbers of the LEX and REX. Package the product appropriately for safe shipment and mark the RMA number on the outside of the package. The package must be sent prepaid to Icron Technologies Corporation. We recommend that you insure it or send it by a method that provides for tracking of the package. The repaired or replaced item will be shipped to you, at Icron Technologies Corporation's expense, not later than thirty days after Icron Technologies Corporation receives the defective product.

Specifications

RANGE	
Point-to-Point	Up to 200m (656 ft) over OM3 or better multimode fiber
USB DEVICE SUPPORT	
Maximum Throughput	5 Gbps
Traffic Types	All Traffic Types
Device Types	All Device Types
Maximum Number of Devices and/or Hubs	Up to 30 devices
LOCAL EXTENDER (LEX)	
USB Connector	1 x USB 3.1 Gen 1 Type B Receptacle
Link Connector	1 x Duplex LC
Network Pass Through:	1 x RJ45
Dimensions	137.3mm x 232.1mm x 33.0mm (5.4" x 9.1" x 1.3")
Enclosure Material	Silver Anodized Aluminum
Power Supply	100-240V AC Input, 24V 1A DC Output
REMOTE EXTENDER (REX)	
USB Connector	4 x USB 3.1 Gen 1 Type A Receptacles
Link Connector	1 x Duplex LC
Network Pass Through:	1 x RJ45
Dimensions	137.3mm x 232.1mm x 33.0mm (5.4" x 9.1" x 1.3")
Enclosure Material	Silver Anodized Aluminum
Available Current	Up to 1.2 Amp (6W) to each USB port
Power Supply	100-240V AC Input, 24V 2.71A DC Output
ENVIRONMENTAL	
Operating Temperature Range	0°C – 50°C (32°F – 122°F)
Storage Temperature Range	-20°C – 70°C (-4°F – 158°F)
Operating Humidity	20% to 80% relative humidity, non-condensing
Storage Humidity	10% to 90% relative humidity, non-condensing
COMPLIANCE	
EMC	FCC (Class B), CE (Class B)
Environmental	RoHS2 (CE)
SUPPORT	
Warranty	2-year

Contacting Technical Support

If you are experiencing problems not referenced in the Troubleshooting section, contact **Icron Technical Support**:

www.icron.com/support

Tel: +1 604 638 3939

To help us serve you better, please include the following information with your technical support request:

- Host computer make and model
- Type of Operating System installed (e.g. Windows 10, macOS 10.12, etc.)
- Part number and serial number for both the LEX and REX units
- Make and model of any USB device(s) attached to this extender system
- Description of the installation such as Host computer model, transmission media used and information about the USB device(s)
- Description of the problem

Address the returned product to:

RMA Coordinator
Icron Technologies Corporation
4664 Lougheed Highway, Suite 221
Burnaby, BC Canada
V5C 5T5

Contacting Sales

Email: sales@icron.com

Tel: +1 604 638 3920

Technical Glossary

USB 3 and USB 2.0 Cables

USB cables have two distinct full-sized connectors. The Type A connector is used to connect the cable from a USB device to the Type A port on a computer or hub. The Type B connector is used to attach the USB cable to a USB device.

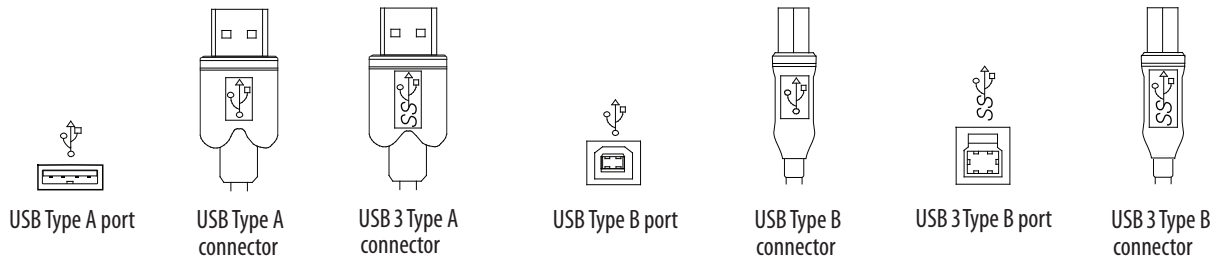

Duplex LC

When a crossover fiber-optic cable is called for, the cable has the transmit signal on one end connected to the receive signal at the other end.

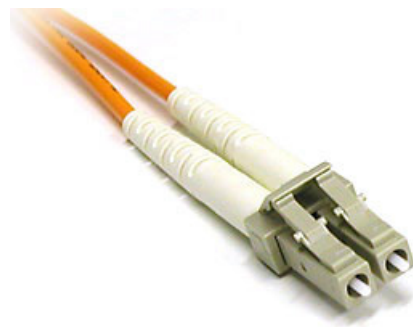



Icron Technologies Corporation
4664 Lougheed Highway, Suite 221
Burnaby, BC Canada
V5C 5T5

Tel: +1 604 638 3920

Fax: +1 604 638 3930

www.icron.com